

IEC61850 通訊協定應用於智慧電網儲能系統

柯侑寬 博士

伊頓飛瑞股份有限公司 協理

智慧電網之微電網儲能系統

Eaton Power Xpert Energy Optimizer controller
is based on open standards, including **IEC 61850** communications.

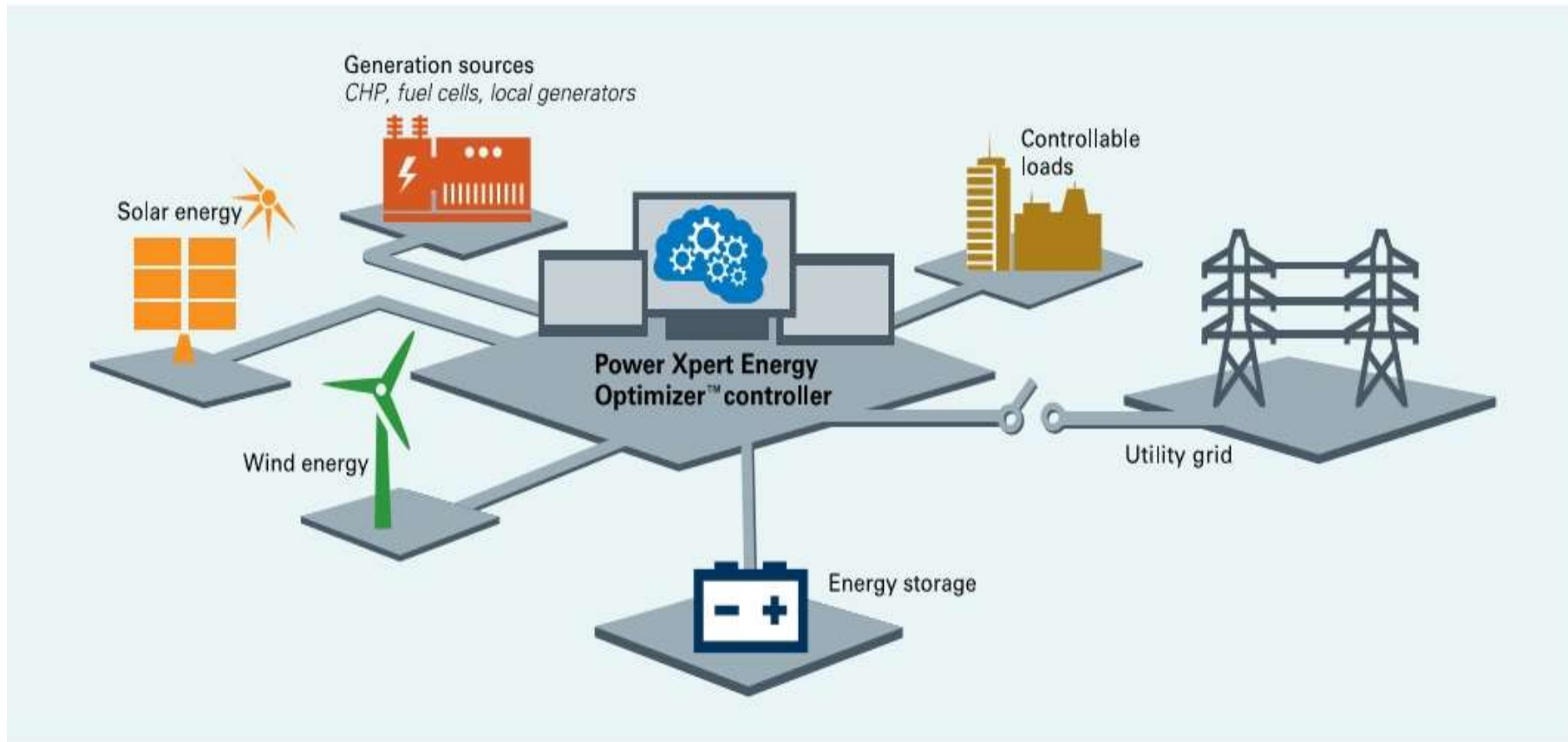

Power Xpert Energy Optimizer controller; the brains of a microgrid or energy storage solution

智慧電網之微電網儲能系統

IEC61850 通訊協定導入在電網之儲能系統中，
電網之能源管理系統能接收到儲能系統之資料

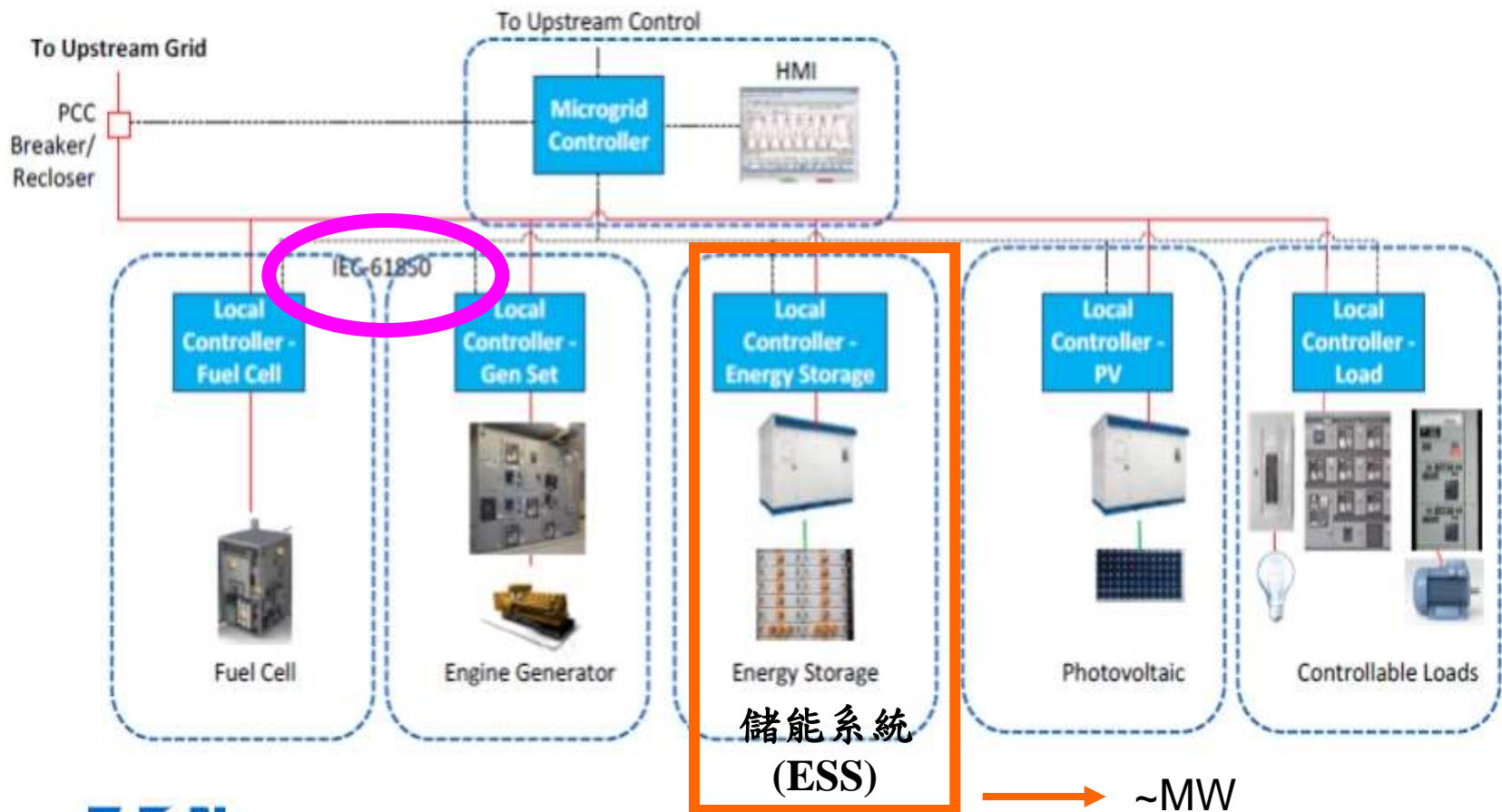

先進微電網儲能系統供電示意圖

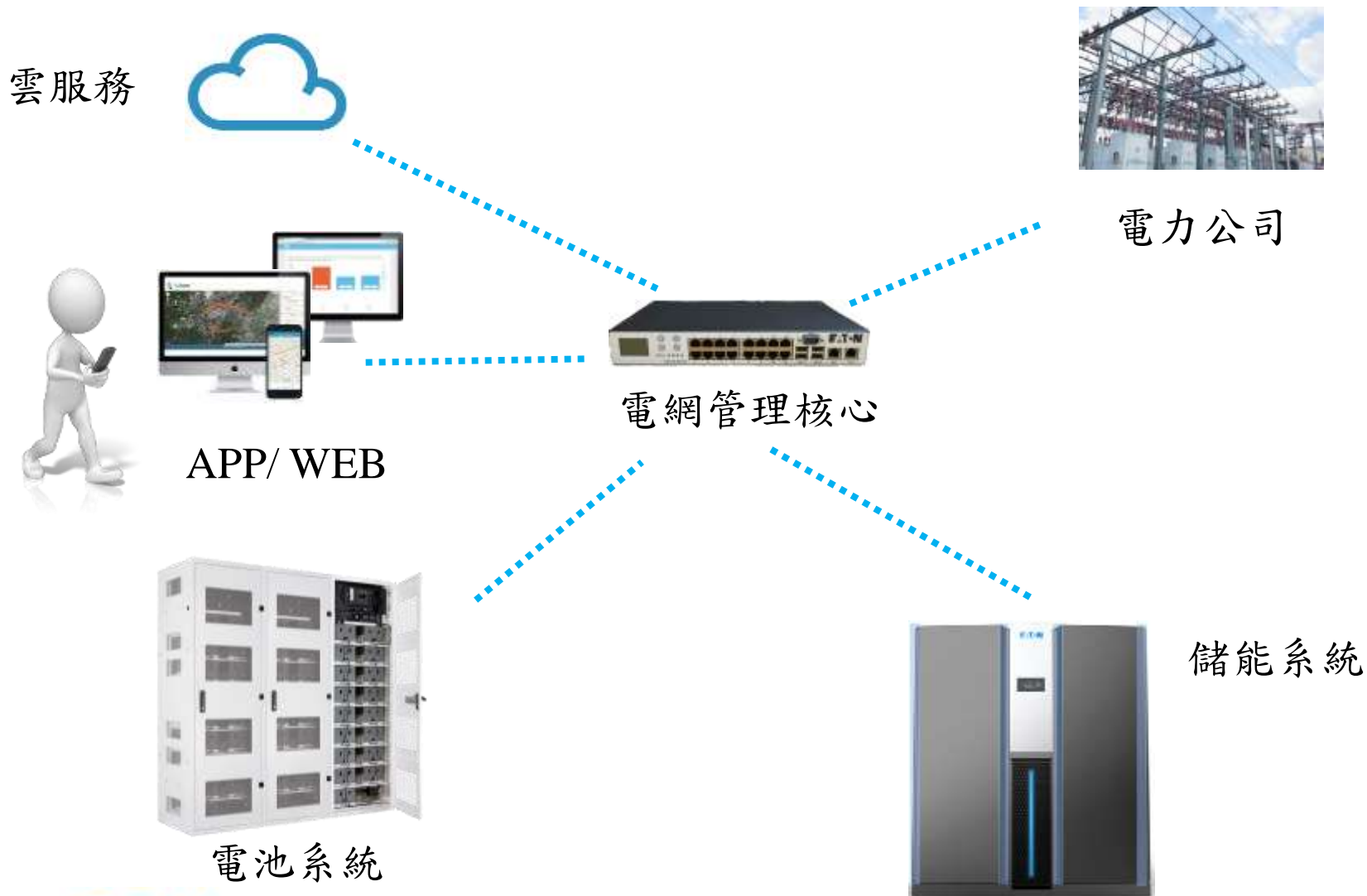

微電網之儲能系統(ESS)

電網級 ESS 儲能系統

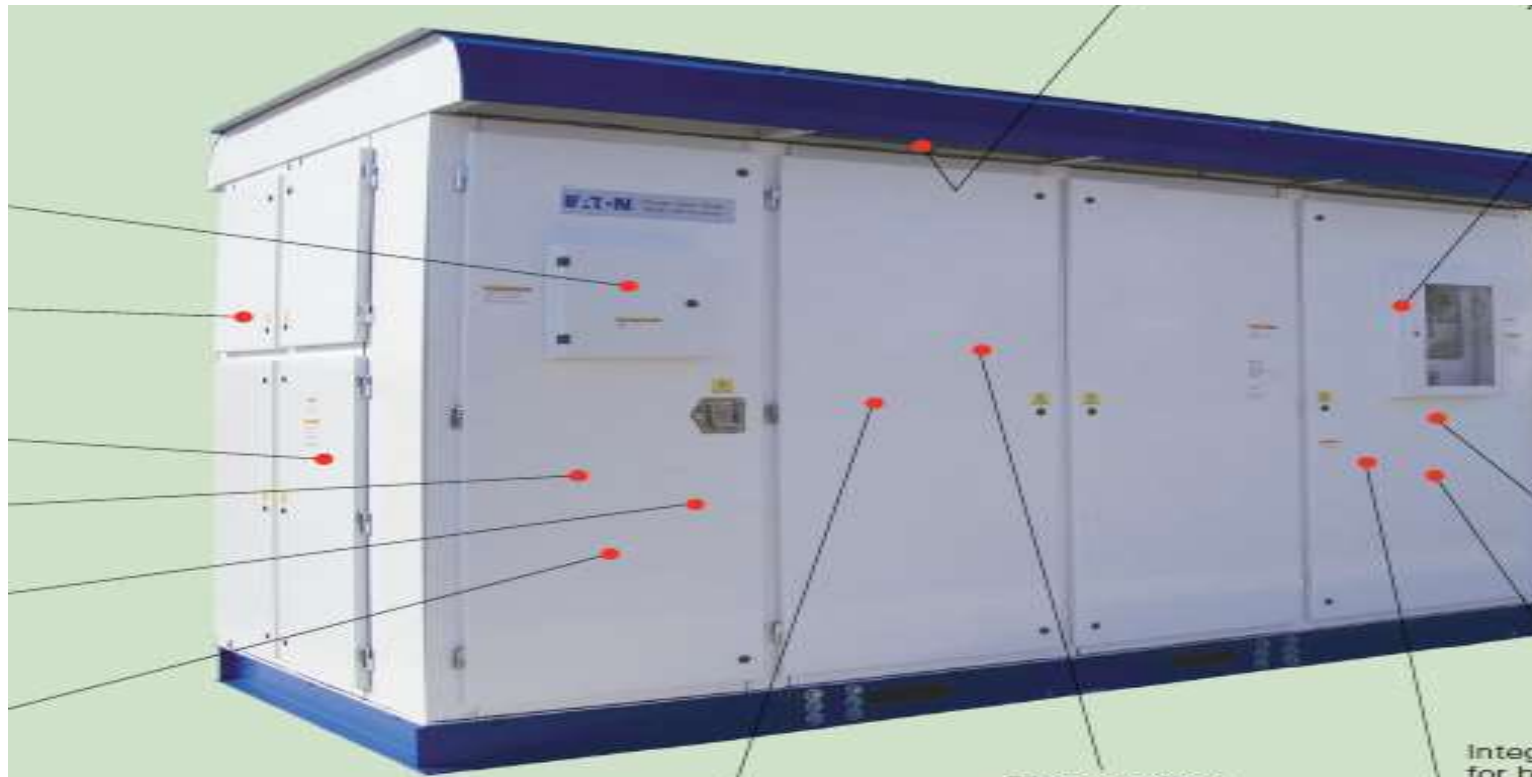

再生能源之儲能系統



Smart Inverter can control VAR and Voltage

IEC61850應用於變電站屬性階層

- IEC61850 應用於變電站之三個階層之分類

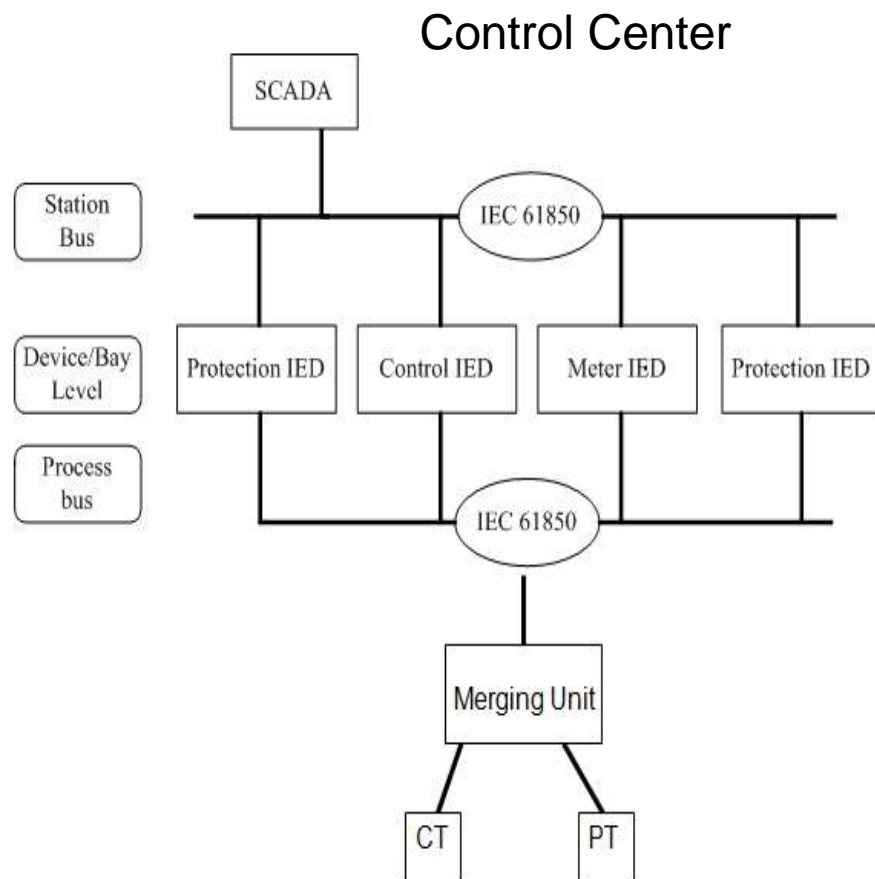
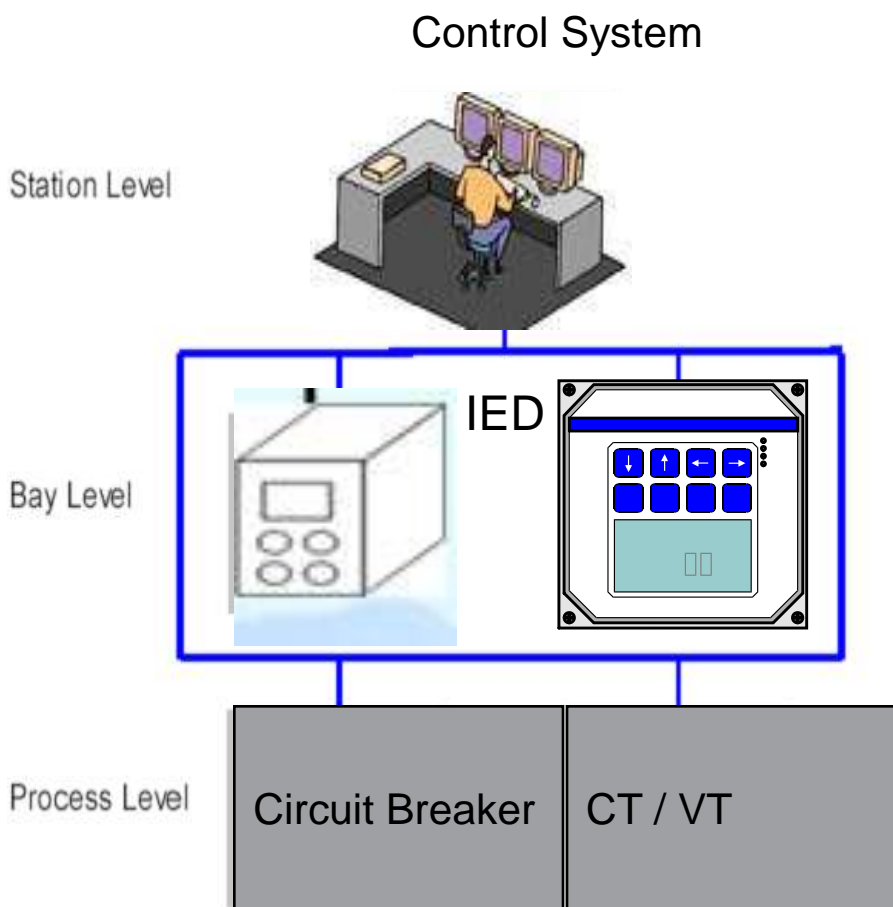

變電站之通訊整合之Gateway for Full IEC61850

Integrate the latest IEC 61850 with legacy RTUs, PLCs, IED and others devices

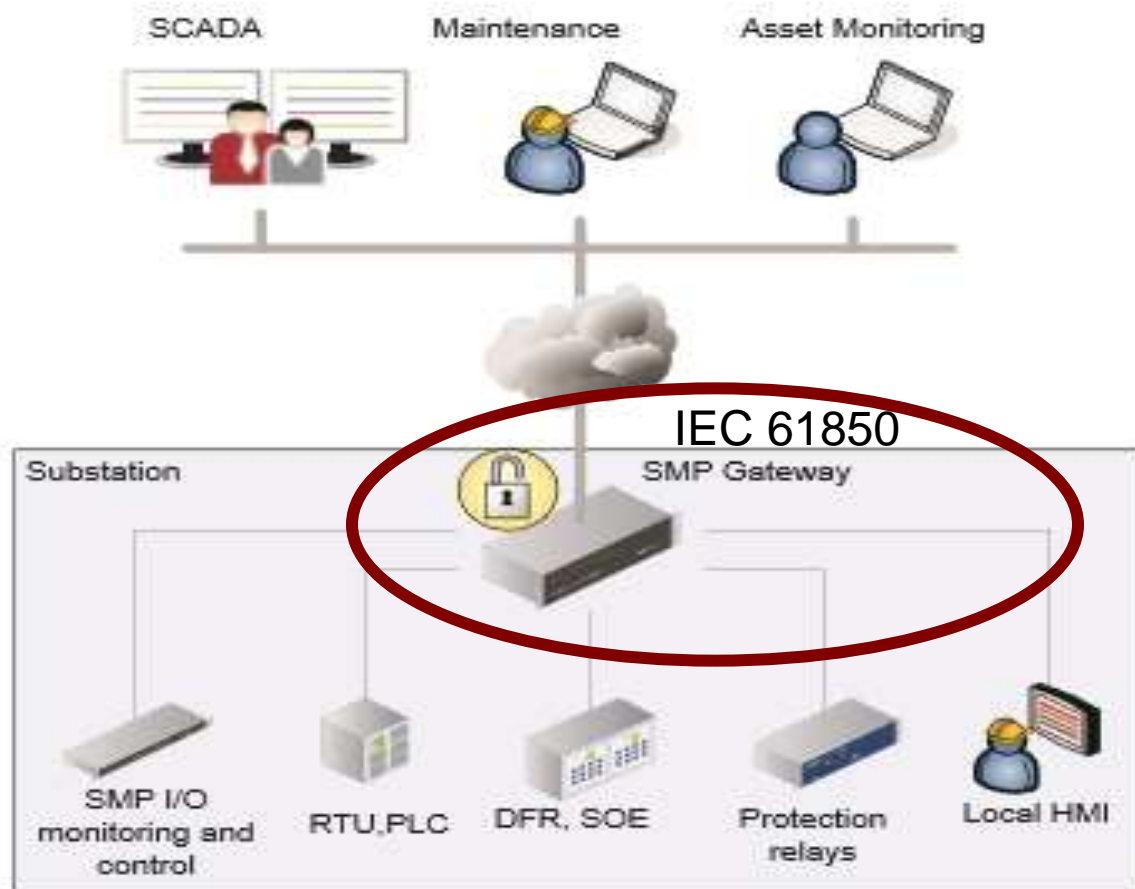

EATON

Powering Business Worldwide